

Data Sheet



Article number: 021816011223

Description: Clamp with bracket and rubber
SPGU 6011. 223/30 SK

Measures

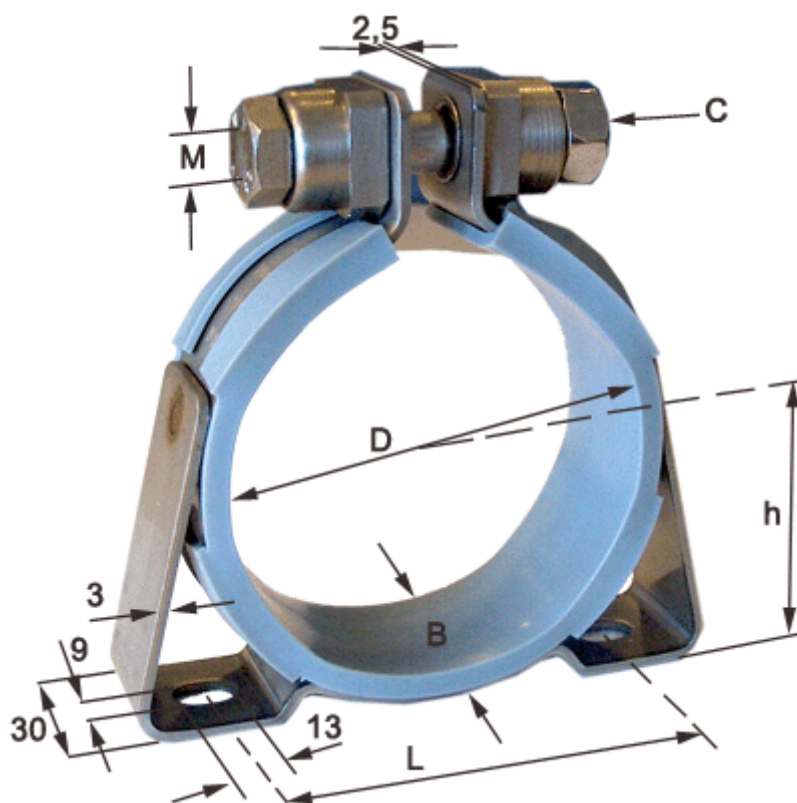

C (screw type) = SK hexagon screw

Diameter D = 223

h = 120

L = 216

Width B = 30